



VIENNA 144 BARHOCKER
&
HOCKER

TECHNISCHES BLATT
SCHEMA TECNICA
DATA SHEET
FICHE TECHNIQUE

VIENNA 144 BARHOCKER & HOCKER

DESIGN GEBRÜDER THONET, 1908



Hocker aus Buchenbugholz in zwei Höhen. Sitz aus Wiener Geflecht, Schichtholz mit Relief oder gepolstert. Nur für höhere Version mit verchromtem Metallring als Fußstütze.

Sgabello in faggio curvato, in due altezze. La seduta è disponibile in paglia di Vienna, in multistrato stampato a rilievo o imbottita. Solo per la versione alta, poggia piedi costituito da un elemento ad anello in metallo cromato.

Bent beech-wood stool, available in 2 heights. Woven cane, stripe pattern plywood or upholstered seat available. Only for the higher version, footrest comprising a chromed metal ring-shaped element.

Tabouret en hêtre cintré, en deux hauteurs. L'assise est disponible en paille de Vienne, en contreplaqué imprimé en relief ou rembourrée. Uniquement pour la version la plus haute, repose-pieds constitué d'un élément en forme d'anneau en métal chromé.

Taburete en haya curvada, en dos alturas. El asiento está disponible en paja de Viena o en multicapa gofrada o tapizado. Solo para la versión alta, reposapiés confeccionado por un elemento circular en metal cromado.



SAV144LGN
Dimensions mm.

height 850 | width 460 | depth 460



SAV144PGL
Dimensions mm.

height 850 | width 460 | depth 460



SAV144TES
Dimensions mm.

height 850 | width 460 | depth 460



SBV144LGN
Dimensions mm.

height 450 | width 350 | depth 350



SBV144PGL
Dimensions mm.

height 450 | width 350 | depth 350



SBV144TES
Dimensions mm.

height 450 | width 350 | depth 350

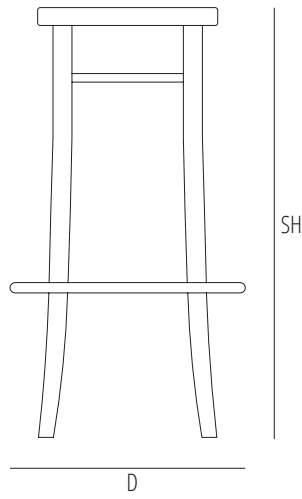
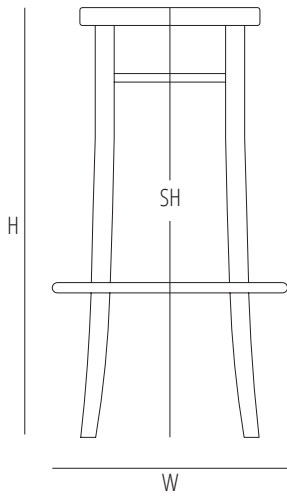

	H	W	D	SH	AH
mm	850	460	460	850	
inch	33,4	18,1	18,1	33,4	

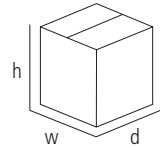
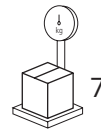
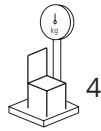
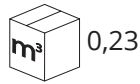

mm - inch
 h 1020 - 40,1
 w 480 - 18,8
 d 480 - 18,8

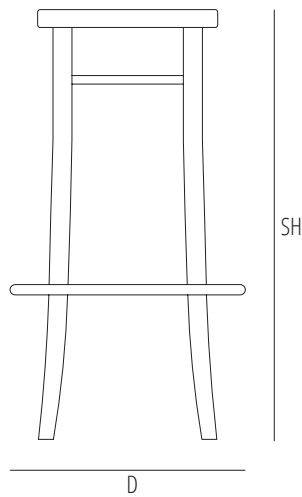
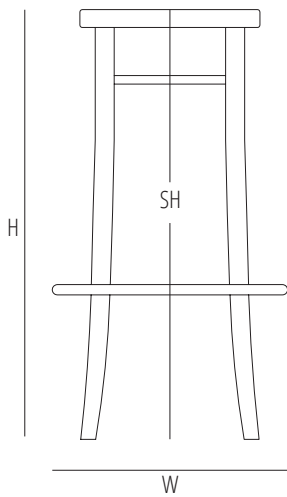

	H	W	D	SH	AH
mm	850	460	460	850	
inch	33,4	18,1	18,1	33,4	

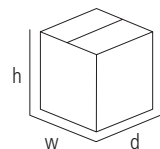
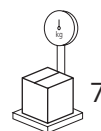
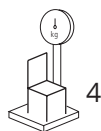
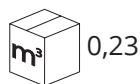

mm - inch
 h 1020 - 40,1
 w 480 - 18,8
 d 480 - 18,8

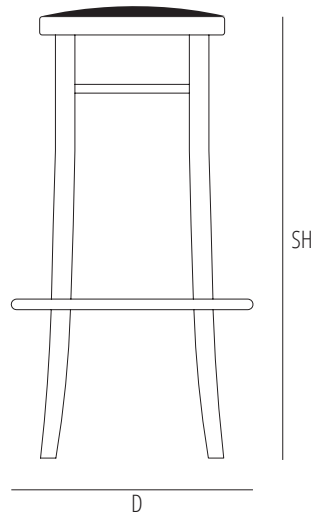
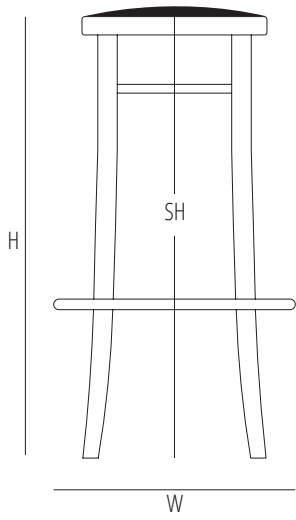

	H	W	D	SH	AH
mm	850	460	460	850	1 Pz/Pc: 40 cm. Linear x 140 cm h/width
inch	33,4	18,1	18,1	33,4	2 Pz/Pc: 40 cm. Linear x 140 cm h/width

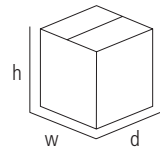
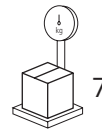
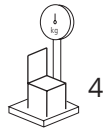
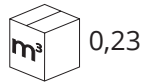
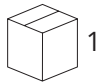

mm - inch
 h 1020 - 40,1
 w 480 - 18,8
 d 480 - 18,8

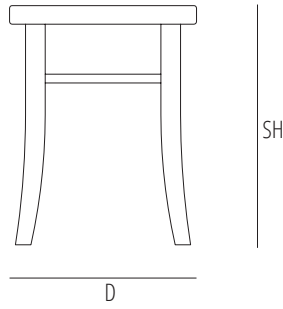
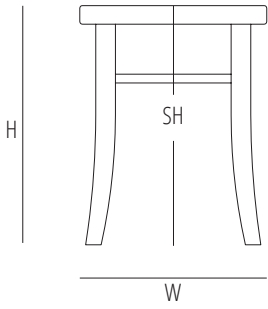

	H	W	D	SH	AH
mm	450	350	350	450	
inch	17,7	13,7	13,7	17,7	

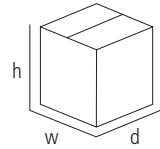
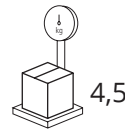
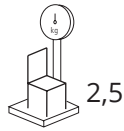
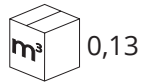

mm - inch
h 920 - 36,2
w 370 - 14,5
d 370 - 14,5

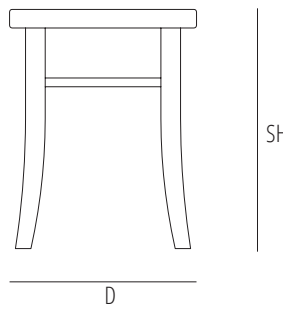
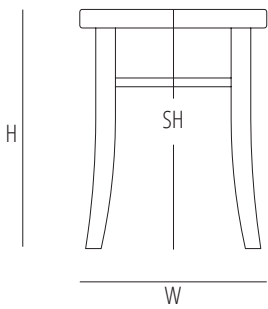

	H	W	D	SH	AH
mm	450	350	350	450	
inch	17,7	13,7	13,7	17,7	

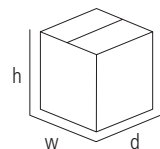
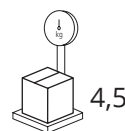
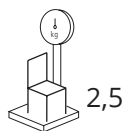
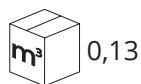

mm - inch
h 920 - 36,2
w 370 - 14,5
d 370 - 14,5

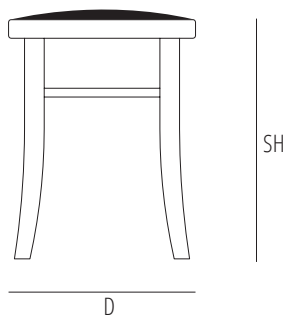
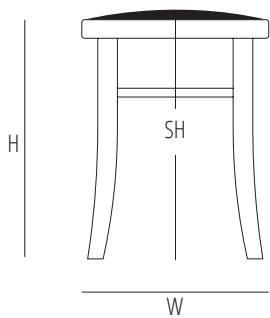

	H	W	D	SH	AH	
mm	450	350	350	450		1 Pz/Pc: 40 cm. Linear x 140 cm h/width
inch	17,7	13,7	13,7	17,7		2 Pz/Pc: 40 cm. Linear x 140 cm h/width

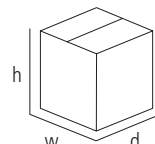
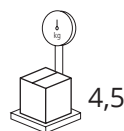
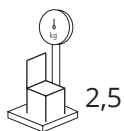
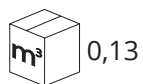

mm - inch
 h 920 - 36,2
 w 370 - 14,5
 d 370 - 14,5

Verfuegbare Ausfuehrungen
Finiture disponibili
Available finishes
Finitions disponibles

SOLID WOOD / ESSENZE NATURALI



B01 BEECH
B01 FAGGIO

STAINS / TINTI



B03 DARK WALNUT
B03 NOCE SCURO



B04 WENGÈ
B04 WENGÈ



B08 BEECH-WOOD STAINED IN NOCE CANALETTO
B08 FAGGIO TINTO NOCE CANALETTO

CLASSIC LACQUER / LACCATO CLASSICO

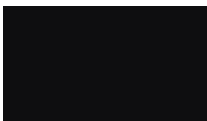

C01 - RAL 9005 BLACK

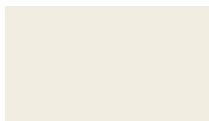

C02 - RAL 9010 PUREWHITE

CONTEMPORARY LACQUER / LACCATO CONTEMPORANEO



D01 - RAL 1013 PEARL WHITE



D03 - RAL 7030 STONE GREY



D11 - RAL 7000 SQUIRREL GREY



D19 - S7502 G DARK GREY



D15 - RAL 5020 OCEAN BLUE



D23 - S6020 G10Y DARK GREEN



D29 - S3060 Y60R RED ORANGE



D14 - RAL 3005 WINE RED

Gebrüder Thonet Vienna GmbH
Prinz Eugen Straße 42
1040 Wien (AT)

www.gebruederthonetvienna.com

Offices of the trademarks' licensee
Production Furniture International S.p.A.
Via Foggia, 23/H
10152 Torino (TO) Italy

Phone: 0039 011 0133330 - info@gebruederthonetvienna.com