



TECHNISCHES BLATT
SCHEDA TECNICA
DATA SHEET
FICHE TECHNIQUE

TRIO

DESIGN MARTINO GAMPER, 2015



Barhocker aus Buch mit Fußstütze.
Sitz aus Schichtholz oder gepolstert.

Sgabello da bar in faggio curvato
con poggiapiedi. Seduta in
multistrato o imbottita.

Bent beech-wood barstool with
footrest. Plywood or upholstered
seat available.

Tabouret bar en hêtre cintré avec
repose-pieds. Assise en
contreplaqué ou rembourrée.

Counter Hocker aus Buche mit
Fußstütze. Sitz aus Schichtholz oder
gepolstert.

Sgabello counter in faggio
curvato con poggiapiedi. Seduta
in multistrato o imbottita.

Bent beech-wood counter stool
with footrest. Plywood or
upholstered seat available.

Tabouret bar en hêtre cintré,
assise h 65 cm, avec repose-
pieds. Assise en contreplaqué ou
rembourrée.

Hocker aus Buchenbugholz. Sitz
aus Schichtholz oder gepolstert.

Sgabello basso in faggio curvato.
Seduta in multistrato o
imbottita.

Bent beech-wood stool.
Plywood or upholstered seat.

Tabouret bas en hêtre cintré.
Assise en contreplaqué ou
rembourrée.



**SATRIOLGN
SATRIOTES**

Dimensions mm.

height 770 | width 440 | depth 440



**SMTRIOLGN
SMTRIOTES**

Dimensions mm.

height 650 | width 440 | depth 440



**SBTRIOLGN
SBTRIOTES**

Dimensions mm.

height 460 | width 400 | depth 380

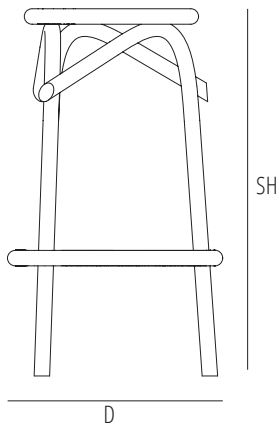
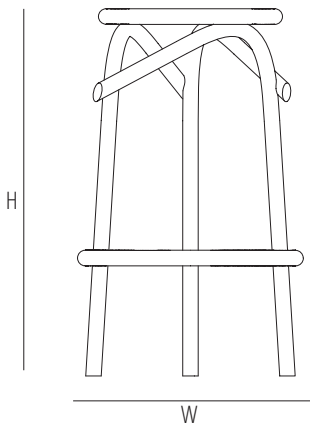

	H	W	D	SH	AH
mm	770	440	440	770	
inch	30,3	17,3	17,3	30,3	

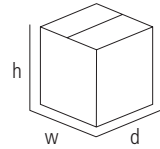
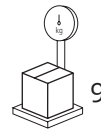
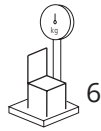
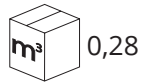

mm - inch
h 1000 - 39,3
w 500 - 19,6
d 550 - 21,6

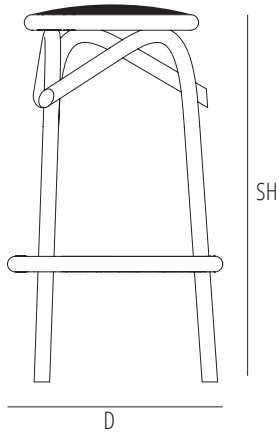
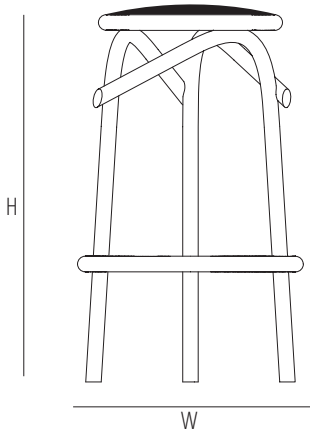

	H	W	D	SH	AH
mm	770	440	440	770	
inch	30,3	17,3	17,3	30,3	

1 Pz/Pc: 40 cm. Linear x 140 cm h/width
2 Pz/Pc: 40 cm. Linear x 140 cm h/width

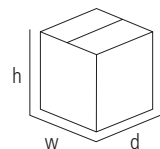
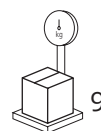
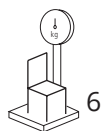
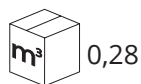

mm - inch
h 1000 - 39,3
w 500 - 19,6
d 550 - 21,6

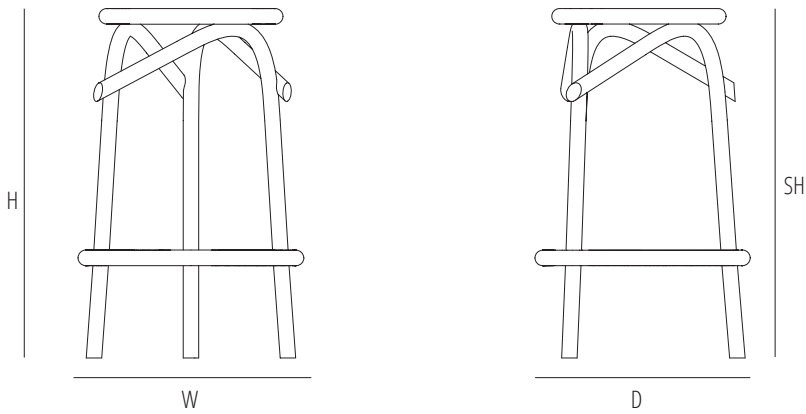

	H	W	D	SH	AH
mm	650	440	440	650	
inch	25,5	17,3	17,3	25,5	

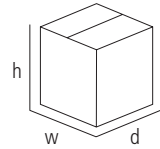
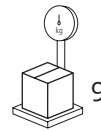
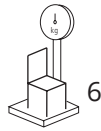
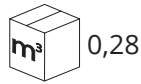

mm - inch
h 1000 - 39,3
w 500 - 19,6
d 550 - 21,6

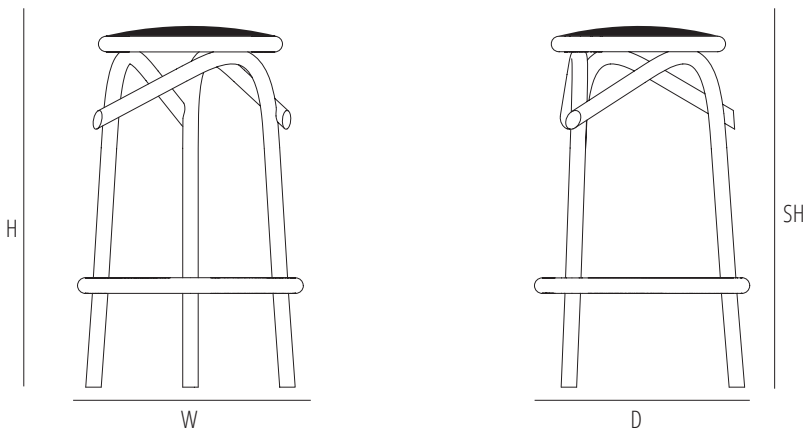

	H	W	D	SH	AH
mm	650	440	440	650	
inch	25,5	17,3	17,3	25,5	

1 Pz/Pc: 40 cm. Linear x 140 cm h/width
2 Pz/Pc: 40 cm. Linear x 140 cm h/width

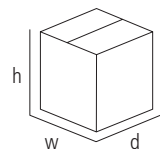
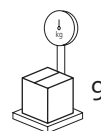
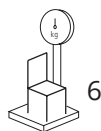
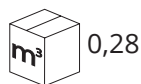

mm - inch
h 1000 - 39,3
w 500 - 19,6
d 550 - 21,6

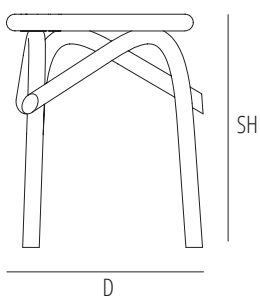
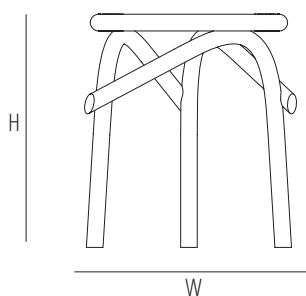

	H	W	D	SH	AH
mm	460	400	380	460	
inch	18,1	15,7	14,9	18,1	

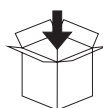
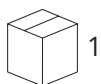

max. 1

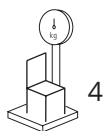
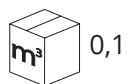

4

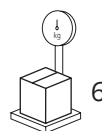

6

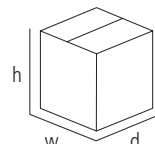

mm - inch
h 540 - 21,2
w 460 - 18,1
d 460 - 18,1

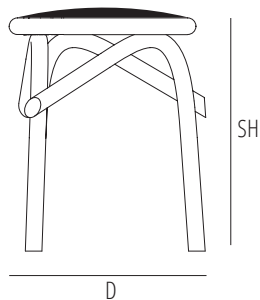
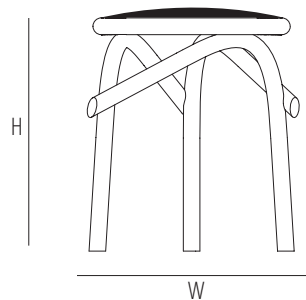

	H	W	D	SH	AH
mm	460	400	380	460	
inch	18,1	15,7	14,6	18,1	

1 Pz/Pc: 40 cm. Linear x 140 cm h/width

2 Pz/Pc: 40 cm. Linear x 140 cm h/width

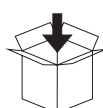
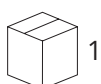

max. 1

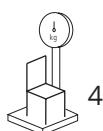
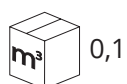

4

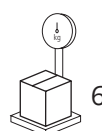

6

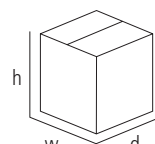

mm - inch
h 540 - 21,2
w 460 - 18,1
d 460 - 18,1

Verfuegbare Ausfuehrungen
Finiture disponibili
Available finishes
Finitions disponibles

SOLID WOOD / ESSENZE NATURALI



B01 BEECH
B01 FAGGIO

STAINS / TINTI



B03 DARK WALNUT
B03 NOCE SCURO



B04 WENGÈ
B04 WENGÈ



B08 BEECH-WOOD STAINED IN NOCE CANALETTO
B08 FAGGIO TINTO NOCE CANALETTO

CLASSIC LACQUER / LACCATO CLASSICO

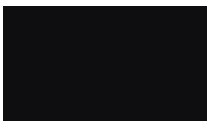

C01 - RAL 9005 BLACK

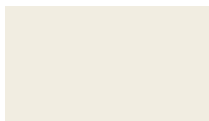

C02 - RAL 9010 PUREWHITE

CONTEMPORARY LACQUER / LACCATO CONTEMPORANEO



D01 - RAL 1013 PEARL WHITE



D03 - RAL 7030 STONE GREY



D11 - RAL 7000 SQUIRREL GREY



D19 - S7502 G DARK GREY



D15 - RAL 5020 OCEAN BLUE



D23 - S6020 G10Y DARK GREEN



D29 - S3060 Y60R RED ORANGE



D14 - RAL 3005 WINE RED

Gebrüder Thonet Vienna GmbH
Prinz Eugen Straße 42
1040 Wien (AT)

www.gebruederthonetvienna.com

Offices of the trademarks' licensee
Production Furniture International S.p.A.
Via Foggia, 23/H
10152 Torino (TO) Italy

Phone: 0039 011 0133330 - info@gebruederthonetvienna.com