



# POSTSPARKASSE

TECHNISCHES BLATT  
SCHEDA TECNICA  
DATA SHEET  
FICHE TECHNIQUE

# POSTSPARKASSE

DESIGN OTTO WAGNER, 1906



Armstuhl aus Buchenbugholz. Sitz aus Schichtholz mit Lochmuster oder gepolstert. Mit oder ohne Aluminium- oder Kupferbeschläge.

Poltroncina in faggio curvato. La seduta è disponibile in multistrato traforato o imbottita. Disponibile con o senza dettagli in alluminio o rame.

Bent beech-wood armchair. With perforated plywood or upholstered seat. Available with or without aluminum or copper details.

Petit fauteuil en hêtre cintré. Assise en contreplaqué ajouré ou rembourrée. Disponible avec ou sans les détails en aluminium ou cuivre.

Butaca en haya curvada. El asiento está disponible en multicapa perforada o tapizado. Disponible con o sin detalles en aluminio o cobre.



**PTPSTKLGN**

Dimensions mm.

height 790 | width 560 | depth 590



**PTPSTKTES**

Dimensions mm.

height 790 | width 560 | depth 590



**PTPSTKLGA**

Dimensions mm.

height 790 | width 560 | depth 590



**PTPSTKTEA**

Dimensions mm.

height 790 | width 560 | depth 590

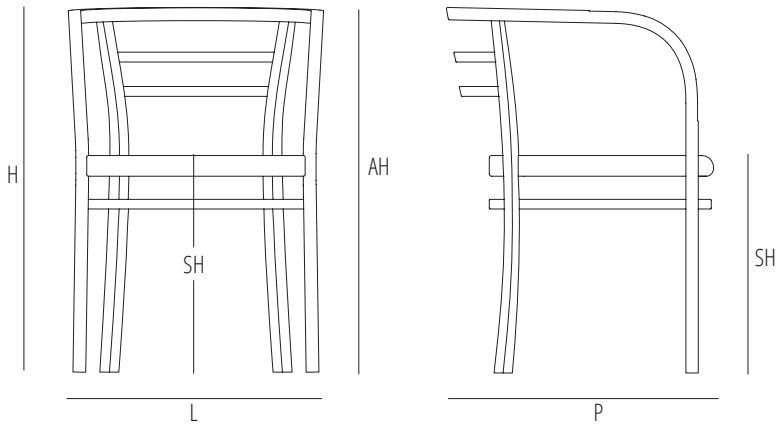

	H	W	D	SH	AH
mm	790	560	590	470	790
inch	31,1	22	23,2	18,5	31,1

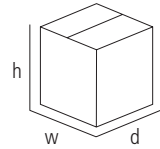
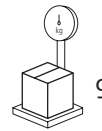
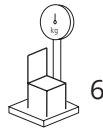
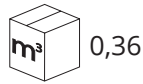
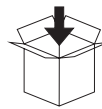
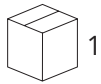

mm - inch  
h 960 - 37,7  
w 620 - 24,4  
d 600 - 23,6

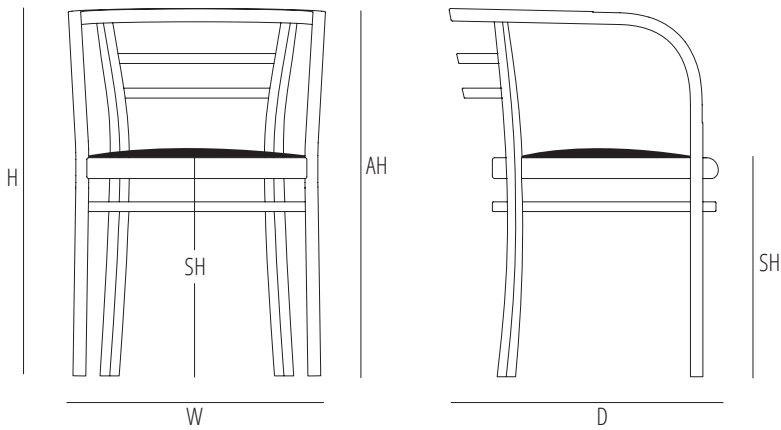

	H	W	D	SH	AH	
mm	790	560	590	470	790	1 Pz/Pc: 70 cm. Linear x 140 cm h/width
inch	31,1	22	23,2	18,5	31,1	2 Pz/Pc: 70 cm. Linear x 140 cm h/width

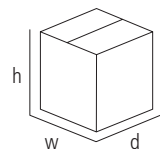
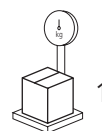
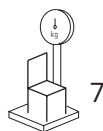
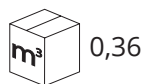
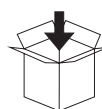
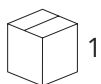

mm - inch  
h 960 - 37,7  
w 620 - 24,4  
d 600 - 23,6

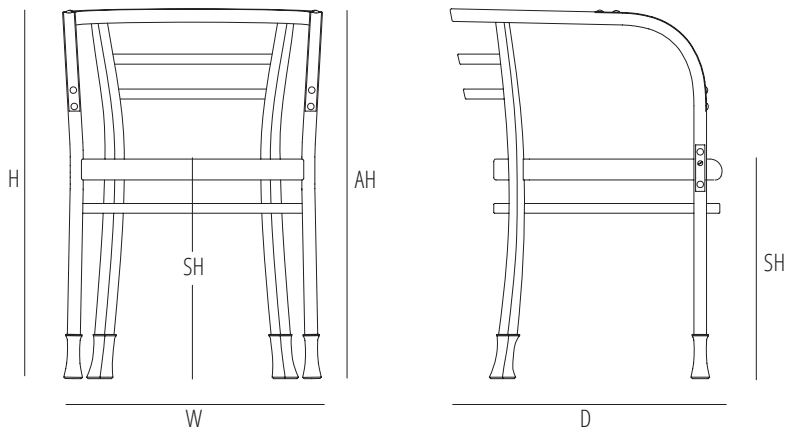

	H	W	D	SH	AH
mm	790	560	590	470	790
inch	31,1	22	23,2	18,5	31,1

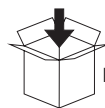

max. 1

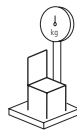
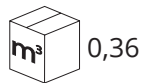

6,5

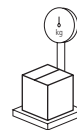

9,5

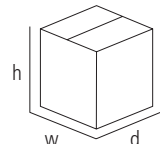

mm - inch  
h 960 - 37,7  
w 620 - 24,4  
d 600 - 23,6

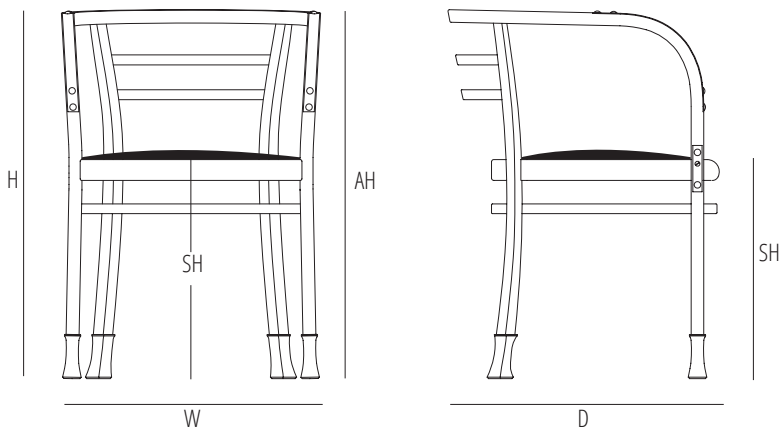

	H	W	D	SH	AH	
mm	790	560	590	470	790	1 Pz/Pc: 70 cm. Linear x 140 cm h/width
inch	31,1	22	23,2	18,5	31,1	2 Pz/Pc: 70 cm. Linear x 140 cm h/width

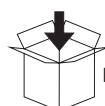

max. 1

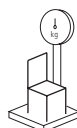
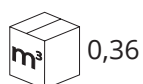

7,5

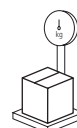

10,5

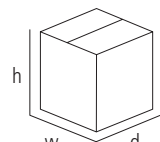

mm - inch  
h 960 - 37,7  
w 620 - 24,4  
d 600 - 23,6

Verfuegbare Ausfuehrungen  
Finiture disponibili  
Available finishes  
Finitions disponibles

## SOLID WOOD / ESSENZE NATURALI

---



B01 BEECH  
B01 FAGGIO

## STAINS / TINTI

---



B03 DARK WALNUT  
B03 NOCE SCURO



B04 WENGÈ  
B04 WENGÈ



B08 BEECH-WOOD STAINED IN NOCE CANALETTO  
B08 FAGGIO TINTO NOCE CANALETTO

## CLASSIC LACQUER / LACCATO CLASSICO

---



C01 - RAL 9005 BLACK

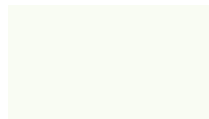

C02 - RAL 9010 PURE WHITE

Gebrüder Thonet Vienna GmbH  
Prinz Eugen Straße 42  
1040 Wien (AT)

**[www.gebruederthonetvienna.com](http://www.gebruederthonetvienna.com)**

Offices of the trademarks' licensee  
Production Furniture International S.p.A.  
Via Foggia, 23/H  
10152 Torino (TO) Italy

Phone: 0039 011 0133330 - [info@gebruederthonetvienna.com](mailto:info@gebruederthonetvienna.com)