



SINGLE CURVE BARSTOOL & COUNTER

TECHNISCHES BLATT
SCHEDA TECNICA
DATA SHEET
FICHE TECHNIQUE

SINGLE CURVE BARSTOOL & COUNTER

DESIGN NENDO, 2015



Barhocker aus Buchenbugholz.
Sitz aus Schichtholz oder Wiener
Geflecht. Fußstütze mit Messing
beschichtet.

Sgabello da bar in faggio curvato.
Seduta in multistrato o in paglia di
Vienna. Barra poggiapiedi rivestita in
ottone.

Bent beech-wood barstool.
Plywood or woven cane seat.
Brass covered footrest.

Tabouret bar en hêtre cintré. Assise
en contreplaqué ou en paille de
Vienne. Barre repose-pied
recouverte de laiton.

Taburete de bar en haya curvada.
Asiento multicapa o en paja de
Vienna. Barra reposapiés revestida en
latón.

Counter Hocker aus Buchenbugholz.
Sitz aus Schichtholz oder Wiener
Geflecht. Fußstütze mit Messing
beschichtet.

Sgabello counter in faggio curvato.
Seduta in multistrato o in paglia di
Vienna. Barra poggiapiedi rivestita in
ottone.

Bent beech-wood counter stool.
Plywood or woven cane seat.
Brass covered footrest.

Tabouret bar en hêtre cintré, assise h
65 cm. Assise en contreplaqué ou en
paille de Vienne. Barre repose-pied
recouverte de laiton.

Taburete counter de bar en haya
curvada. Asiento multicapa o en paja
de Vienna. Barra reposapiés revestida
en latón.



SANSTOLGN

Dimensions mm.

height 870 | width 540 | depth 420



SANSTOPGL

Dimensions mm.

height 870 | width 540 | depth 420



SMNSTOLGN

Dimensions mm.

height 780 | width 540 | depth 420



SMNSTOPGL

Dimensions mm.

height 780 | width 540 | depth 420

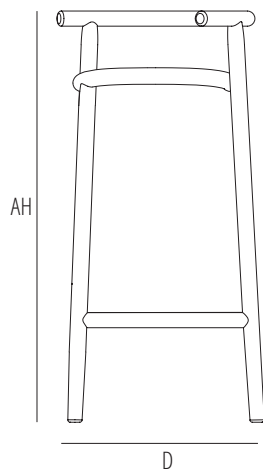
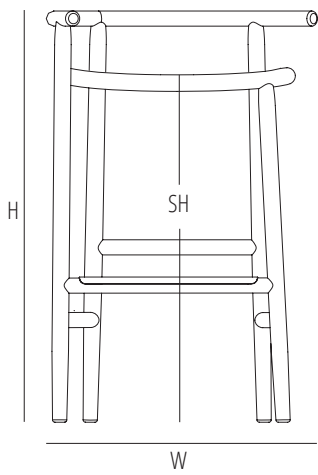

	H	W	D	SH	AH
mm	870	540	420	740	870
inch	34,2	21,2	16,5	29,1	34,2

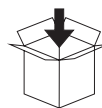
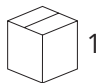

max. 1

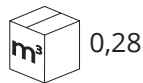

0,28

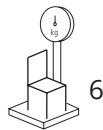

6

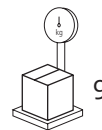

9

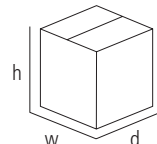

mm - inch
h 1000 - 39,3
w 500 - 19,6
d 500 - 19,6

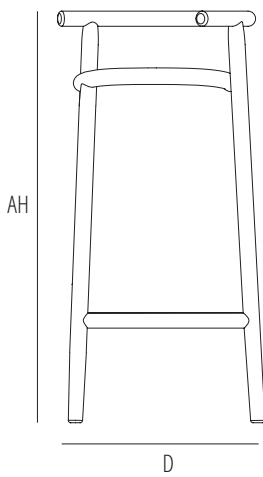
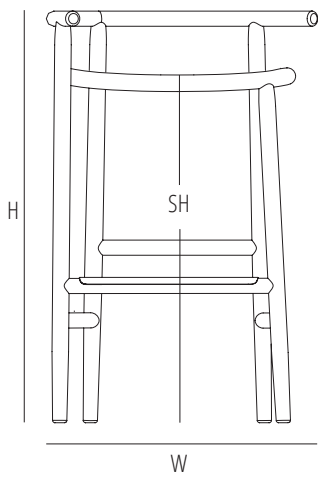

	H	W	D	SH	AH
mm	870	540	420	740	870
inch	34,2	21,2	16,5	29,1	34,2

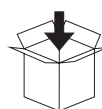
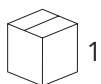

max. 1

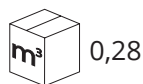

0,28

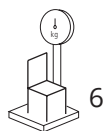

6

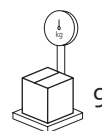

9

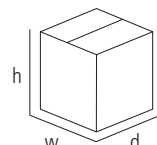

mm - inch
h 1000 - 39,3
w 500 - 19,6
d 500 - 19,6

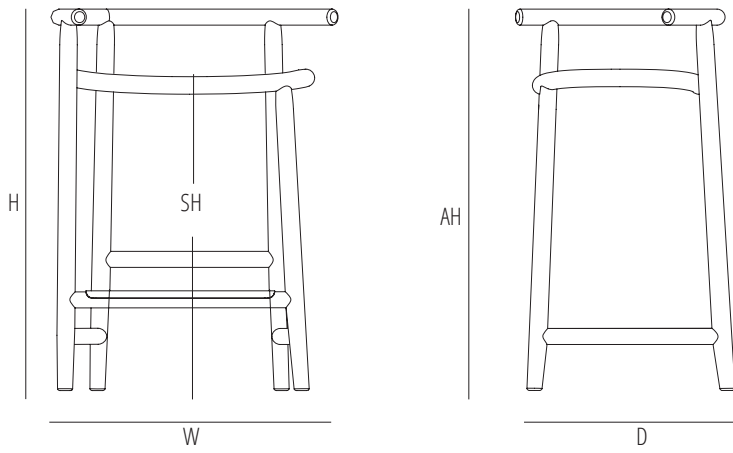

	H	W	D	SH	AH
mm	780	540	420	650	780
inch	30,7	21,2	16,5	25,6	30,7

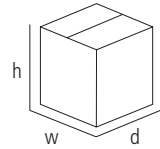
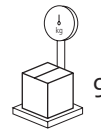
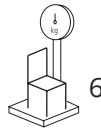
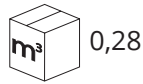
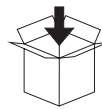
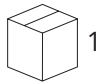

mm - inch
h 850 - 33,5
w 500 - 19,6
d 550 - 21,6

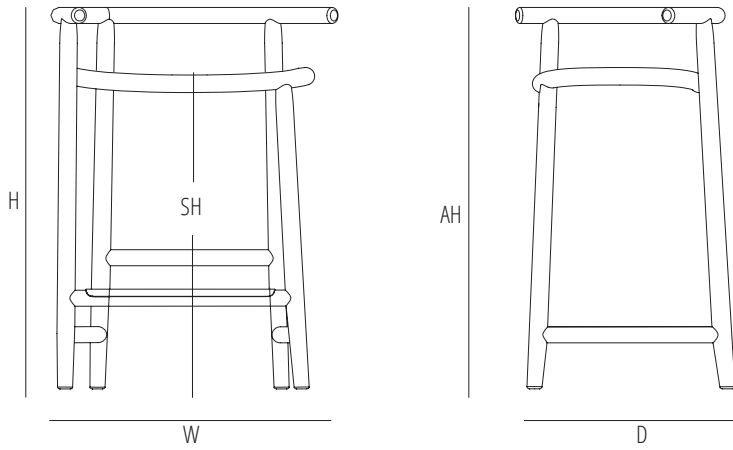

	H	W	D	SH	AH
mm	780	540	420	650	780
inch	30,7	21,2	16,5	25,6	30,7

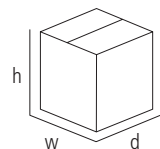
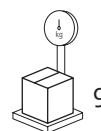
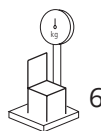
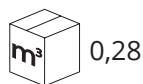
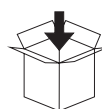
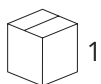

mm - inch
h 850 - 33,5
w 500 - 19,6
d 550 - 21,6

Verfuegbare Ausfuehrungen
Finiture disponibili
Available finishes
Finitions disponibles

SOLID WOOD / ESSENZE NATURALI



B01 BEECH
B01 FAGGIO

STAINS / TINTI

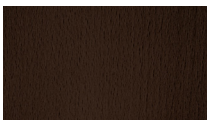

B03 DARK WALNUT
B03 NOCE SCURO

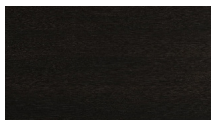

B04 WENGÈ
B04 WENGÈ



B08 BEECH-WOOD STAINED IN NOCE CANALETTO
B08 FAGGIO TINTO NOCE CANALETTO

CLASSIC LACQUER / LACCATO CLASSICO



C01 - RAL 9005 BLACK

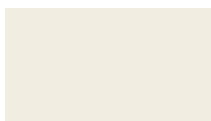

C02 - RAL 9010 PUREWHITE

CONTEMPORARY LACQUER / LACCATO CONTEMPORANEO



D01 - RAL 1013 PEARL WHITE



D03 - RAL 7030 STONE GREY



D11 - RAL 7000 SQUIRREL GREY



D19 - S7502 G DARK GREY



D15 - RAL 5020 OCEAN BLUE



D23 - S6020 G10Y DARK GREEN



D29 - S3060 Y60R RED ORANGE



D14 - RAL 3005 WINE RED

Gebrüder Thonet Vienna GmbH
Prinz Eugen Straße 42
1040 Wien (AT)

www.gebruederthonetvienna.com

Offices of the trademarks' licensee
Production Furniture International S.p.A.
Via Foggia, 23/H
10152 Torino (TO) Italy

Phone: 0039 011 0133330 - info@gebruederthonetvienna.com