



N. 200

TECHNISCHES BLATT
SCHEMA TECNICA
DATA SHEET
FICHE TECHNIQUE

N.200

DESIGN MICHAEL ANASTASSIADES, 2019



Loungesessel aus
dampfgebogenem
Buchenholz.
Sitz und Rückenlehne aus
Wiener Geflecht.

Poltrona lounge in
faggio curvato a vapore.
Seduta e schienale in
paglia di Vienna.

Bent beech-wood
lounge chair.
Woven cane seat
and backrest.

Fauteuil lounge en hêtre
cintré.
Assise et dossier en paille
de Vienne.





PLN200PGL

Dimensions mm.

height 730 | width 630 | depth 775

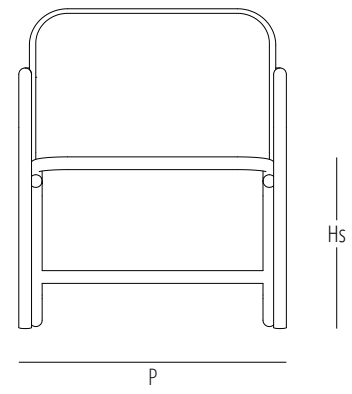
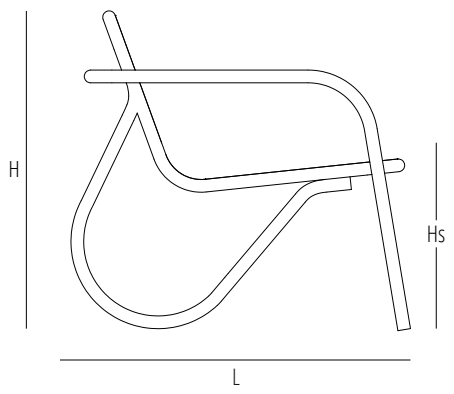
	mm	inch
H	730	28,7
L	755	29,7
P	630	24,8
Hs	425	16,7
Hb		

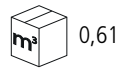
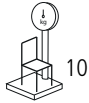
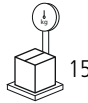
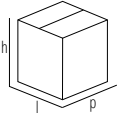

 1
  max 1
  0,61
  10
  15
 

mm - inch
 h 850 - 33,4
 l 900 - 35,4
 p 800 - 31,4

Verfuegbare Ausfuehrungen
Finiture disponibili
Availabe finishes
Finitions disponibles

WOOD



CLASSIC

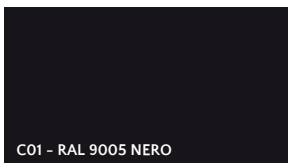

Gebrüder Thonet Vienna GmbH
Prinz Eugen Straße 42
1040 Wien (AT)

www.gebruederthonetvienna.com

Offices of the trademarks' licensee
Production Furniture International S.p.A.
Via Foggia, 23/H
10152 Torino (TO) Italy

Phone: 0039 011 0133330 - info@gebruederthonetvienna.com