



PINCE

TECHNISCHES BLATT
SCHEDA TECNICA
DATA SHEET
FICHE TECHNIQUE

PINCE

DESIGN LUCIDIPEVERE, 2017



Sessel in Monocoque-Struktur mit Stahlrinne und Polsterung aus flexiblem, kalt-geschäumtem Polyurethan. Beine und Rückenlehne aus Eschenbugholz.

Poltroncina con struttura monoscocca con inserto in acciaio e imbottitura in poliuretano flessibile schiumato a freddo. Gambe e schienale in legno di frassino curvato.

Armchair with padded structure and steel insert in flexible coldfoam polyurethane. Legs and back in bent ash-wood.

Fauteuil à structure monocoque doté de parties en acier et rembourré en polyuréthane flexible écumé à froid. Pieds et dossier en bois de frêne cintré.

Butaca con estructura monoscocca con inserto de acero y acolchado de espuma de poliuretano flexible moldeada en frío. Patas y respaldo en madera de fresno curvada.



PTPINCTES

Dimensions mm.

height 780 | width 560 | depth 530

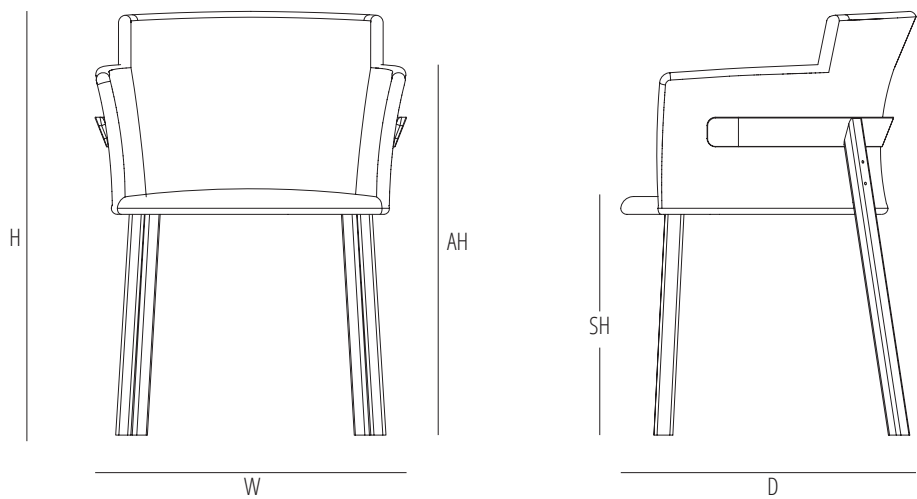

	H	W	D	SH	AH	
mm	780	560	530	450	660	1 Pz/Pc: 190 cm. Linear x 140 cm h/width
inch	30,7	22,8	21,2	17,7	26	2 Pz/Pc: 380 cm. Linear x 140 cm h/width



1



max. 1



0,36

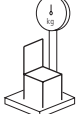

6

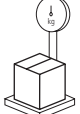

8

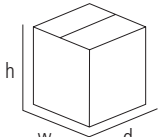

mm - inch
h 960 - 37,7
w 620 - 24,4
d 600 - 23,6

Verfuegbare Ausfuehrungen
Finiture disponibili
Available finishes
Finitions disponibles

SOLID WOOD / ESSENZE NATURALI



B07 ASH
B07 FRASSINO

STAINS / TINTI



B03 DARK WALNUT
B03 NOCE SCURO



B04 WENGÈ
B04 WENGÈ

CLASSIC LACQUER / LACCATO CLASSICO



C01 - RAL 9005 BLACK

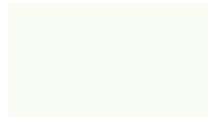

C02 - RAL 9010 PURE WHITE

*Ash wood is open-pore painted
* L'essenza frassino è verniciata a poro aperto

Gebrüder Thonet Vienna GmbH
Prinz Eugen Straße 42
1040 Wien (AT)

www.gebruederthonetvienna.com

Offices of the trademarks' licensee
Production Furniture International S.p.A.
Via Foggia, 23/H
10152 Torino (TO) Italy

Phone: 0039 011 0133330 - info@gebruederthonetvienna.com