



MALIT

TECHNISCHES BLATT
SCHEDA TECNICA
DATA SHEET
FICHE TECHNIQUE

MALIT

DESIGN GEBRÜDER THONET VIENNA GmbH (GTV), 2017



Sessel in Monocoque-Struktur und Polsterung aus flexiblem, kalt-geschäumtem Polyurethan. Fuß aus Buchenbugholz. Polsterung mit Samt nicht verfügbar.

Poltroncina con struttura monoscocca imbottita in poliuretano flessibile schiumato a freddo. Base in legno di faggio curvato. Rivestimento in velluto non disponibile.

Armchair with padded structure in flexible cold-foam polyurethane. Base in bent beech-wood. Upholstery in velvet not available.

Fauteuil à structure monocoque rembourrée en polyuréthane flexible écumé à froid. Base en bois de hêtre cintré. Rembourrage en velours pas disponible.





PTMALATES

Dimensions mm.

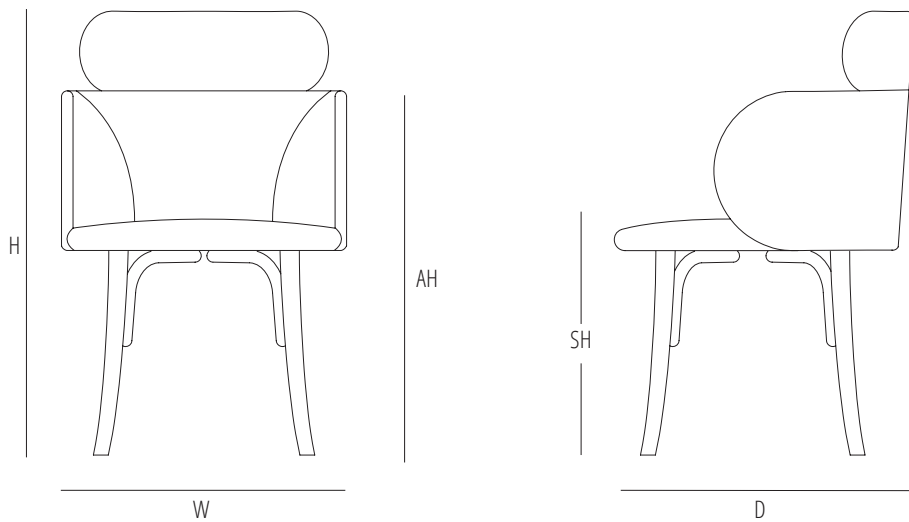
height 830 | width 540 | depth 540

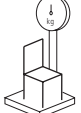
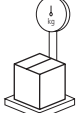
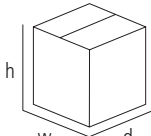

	H	W	D	SH	AH	
mm	830	540	540	450	680	1 Pz/Pc: 170 cm. Linear x 140 cm h/width
inch	32,7	21,2	21,2	17,7	26,8	2 Pz/Pc: 340 cm. Linear x 140 cm h/width

 1	 max. 1	 0,36	 7	 10	 <p>mm - inch h 960 - 37,7 w 620 - 24,4 d 600 - 23,6</p>
--	---	---	--	--	---

Verfuegbare Ausfuehrungen
Finiture disponibili
Available finishes
Finitions disponibles

SOLID WOOD / ESSENZE NATURALI



B01 BEECH
B01 FAGGIO

STAINS / TINTI



B03 DARK WALNUT
B03 NOCE SCURO



B04 WENGÈ
B04 WENGÈ



B05 BEECH GLOSS O
B05 FAGGIO GLOSS O

CLASSIC LACQUER / LACCATO CLASSICO



C01 - RAL 9005 BLACK

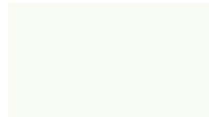

C02 - RAL 9010 PURE WHITE

Gebrüder Thonet Vienna GmbH
Prinz Eugen Straße 42
1040 Wien (AT)

www.gebruederthonetvienna.com

Offices of the trademarks' licensee
Production Furniture International S.p.A.
Via Foggia, 23/H
10152 Torino (TO) Italy

Phone: 0039 011 0133330 - info@gebruederthonetvienna.com